

KRUEGER
transport equipment

KRUEGER.COM.AU

KURTAINER RANGE



ENGINEERED TO BE AN ASSET

Krueger is Australia's leading semi-trailer manufacturer and has been supplying the nation's transport companies with innovative solutions for more than 40 years. Our expertise in technical development and manufacturing has resulted in the production of remarkably versatile trailers that deliver the best in operational performance.

Krueger is a family-owned and operated business boasting innovative freight trailer related products including curtainsiders, open decks, freezer & dry vans, skeletal and trailers featuring numerous OH&S initiatives in load restraint and curtain design. Our trailers are designed to work hard in any environment and are engineered to provide high levels of road transport flexibility and smarter fleet utility for freight operators.



KRUEGER DESIGN ACHIEVEMENTS - NON STOP INNOVATION YEAR ON YEAR

ROOF TRACK One piece extruded alloy track	SLIDING SIDE POST Quick release sliding side post incl. cam leg	CURTAIN RATCHET SEAL Curtain tensioner one hand operation	WEATHER SEAL Fitted front and rear top corner	REAR DOOR Anti rack system	BOLT ON SKID PLATE Standard on all kurtainers	MEZZ DECK System full adjustable	INSULATED CURTAINSIDER Fully insulated roof / floor / curtain	ALLOY EXTRUDED FLOOR Tare weight reduction	AIR SUSPENSION RFS Designed by Krueger for Australian road conditions	SIDE-A-GATE Award winning Load restraint rated sliding gates system	CURTAIN LOAD RESTRAINT RATED Productivity saving OHS friendly	SLIDING MEZZ POST To side-load long cargo	SELF LIFTING GATE Reduce the risk of injury	BUCKLELESS CURTAIN LOAD RESTRAINT RATED OHS friendly / productivity time saving	AUTO MEZZ DECK Requires no removable saddle, OHS friendly	53' TRAILER LENGTH Huge productivity saving	TWO PIECE ROOF TRACK Reduce downtime repair	FREEZER VAN Rolling body / B double	DRY VAN Now available in 2020	HIGH PERFORMANCE RFS PACKAGE Includes million K bearing warranty / 350 air bag / catch strap	ROAD TRAIN DOLLY Heavy duty dolly options for WA and north QLD applications	A-DOUBLE CONFIGURATION 20- and 24 pallet Kurtainer combinations available.
---	---	---	---	--------------------------------------	---	--	---	--	---	---	---	---	---	---	---	---	---	---	---	--	---	--

Krueger has unrivalled experience with the high productivity. Well regarded for analysing trailer procurement strategies, Krueger always ensures that fleet operators make the most of their road transport investments. The team do their due diligence to match equipment or tailor a trailer design for specific freight tasks, best serving the needs of business and industry with the deployment of equipment that boosts payload capacity and efficiency.

Over the decades we have delivered countless businesses Australia wide. To add value, Krueger trailers retain the best resale value in the market after many years of hard work.

STRAIGHT A TRAILER RANGE

- 24 A trailer 12 pallet
- 28 A trailer 14 pallet
- 24 Ultra low neck A 12 pallet
- 28 Ultra low neck A 14 pallet
- 24 Rolling body A 12 pallet
- 28 Rolling body A 14 pallet

STRAIGHT B TRAILER RANGE

- 45 B trailer 22 pallet
- 45 B ultra low neck 22 pallet

STRAIGHT B DOUBLE COMBINATION

- 34-pallet Kurtainer std / ultra low
- 36-pallet Kurtainer std / ultra low

STRAIGHT NON B RATED

- 45 Kurtainer 22 Pallet
- 48 Same above 24 pallet
- 53 Same above 26 pallet

DROP DECK NON B RATED

- 45 Kurtainer 22 pallet
- 48 Kurtainer 24 pallet
- 53 Kurtainer 26 pallet
- Single / double drop / triple drop option

DROP DECK A TRAILER 34 PALLET RANGE

- 24 A trailer single drop 12 / 14 pallet
- 24 A trailer double drop 12 / 14 pallet

DROP DECK B TRAILER 34 PALLET RANGE

- 45 B trailer single drop 22 pallet
- 45 B trailer double drop 22 pallet

36 PALLET B DOUBLE RANGE OUTER PERIMETER

- 28 A trailer single drop 14 pallet outer perimeter chassis
- 45 B trailer single drop 22 pallet outer perimeter chassis
- 28 A trailer double drop 14 pallet outer perimeter chassis
- 45 B trailer double drop 22 pallet outer perimeter chassis
- 45 B trailer (triple drop) 22 pallet outer perimeter chassis

A DOUBLE COMBINATION

- 40 lead Kurtrailer A-double 20-pallet combination
- 48 lead Kurtrailer A-double 24-pallet combination

ROAD TRAIN DOLLY STD / HEAVY DUTY

- Metropolitan A double dolly fixed and extended draw bar
- Heavy duty dolly to suit WA / north QLD / other

ULTRA LOW NECK

INCREASED CAPACITY

FEATURES & BENEFITS

- 4,600mm overall height in combination with ultra low neck has largest side opening available to curtain sider floor to roof track 3135mm increase in cubic capacity x M3
- Palletised cargo capacity 26 pallet direct on floor or 52 stacked two-high plus three-high if required
- Cubic capacity when compared with typical 45 drop deck increase by M3
- Buckless curtain load restraint rated req. no tie down subject to type of cargo / OH&S friendly heavy duty system is air operated and take only minutes per side to open / close
- Fuel efficient side curtain incl. two vertical carbon fibre flat bar per pallet incorporated into curtain pocket attached to heavy duty over head roller carriage clamped down by heavy duty locking lever at side coaming the curtain remain very ridged in windy conditions equals less wind drag
- Return on investment. The cost to increase trailer height and length from 45 to 53 would have less than one year pay back

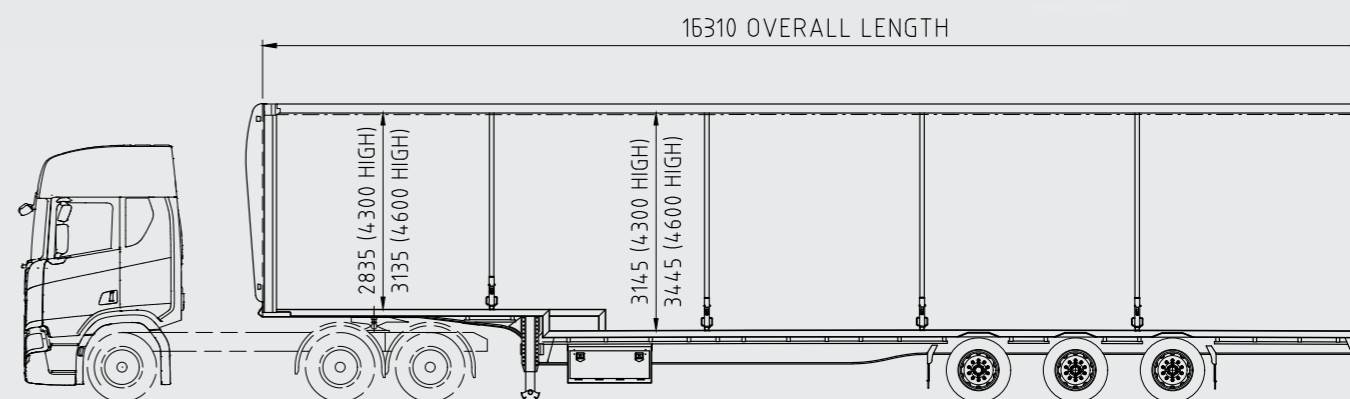

53' STRAIGHT

LOAD RESTRAINT

FEATURES & BENEFITS

- 26-pallet capacity rear-end loading
- Auto powered roller door operated by remote control, brake interlock system prevent trailer being towed unless rear door closed
- Sliding forklift barrier allows for side- and rear-loading is very versatile
- Forklift-rated floor incl. heavy duty threshold plate at rear door opening
- Dock sensing applies trailer brake just before trailer rear end makes contact with loading dock
- Cargo track full length floor to roof provide longitudinal load restraint
- Access ladder incl. three points of contact in safety yellow incl. anti-slip foot rest
- Load restraint rated curtain, two buckles per pallet space



36-PALLET DROP DECK

PRODUCTIVITY AND OH&S

FEATURES & BENEFITS

- High productivity Curtain OH&S-friendly. Speeds up turnaround time by reducing curtain buckles from the B-double – 68 down to just 26; a massive decrease as each buckle is positioned to reduce wind drag while providing weather protection
- Overhead suspended load binder incl. right drive load binder ratchet
- Internal load nets provide longitudinal load support
- Auto ratchet deck is raised and lowered by one person driving the forklift; there are no saddles, it simply locks into the desired position i.e. self locking lever



LOCKED
Green visual marker displayed

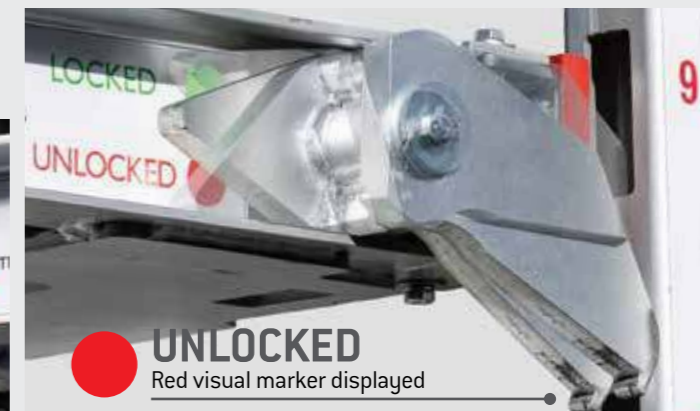

36-PALLET TRIPLE DROP PBS

SELF LIFTING GATES

FEATURES & BENEFITS

- 4,600 mm overall height, maximum internal aperture
- Huge pallet capacity from top to bottom
- Triple drop at rear to achieve maxi pallet capacity / height
- Mezzanine deck 4' low profile full adjustable
- Side gate self lifting OH&S-friendly req. no manual lifting
- Load restraint sidecurtain incl. two buckles per pallet space
- DG wiring incl. DG curtain pocket fire
- Bolt on skid / greaseless air operated just turn table



STEP 1: LIFT TO RELEASE FROM STANDARD POSITION



STEP 2: PULL LEVER DOWNWARDS TO LIFT AND RELEASE



STEP 3: LOWER AND SMOOTHLY SLIDE GATE SIDWAYS



STEP 4: GATES CAN BE STACKED ONE OVER THE OTHER FOR EASY ACCESS

48' DROP DECK MEZZ DECK

FLEXIBILITY

FEATURES & BENEFITS

- 45 / 48 / 53 single / double drop / triple drop option
- Mezzanine deck option standard deck / auto ratchet
- Sliding mezzanine post for side loading long cargo
- Heavy duty option incl. road train ringfeeder
- Heavy duty accessories incl. tool box / tyre carrier / mud guard / other
- Dangerous goods wiring loom / fire extinguisher / DG sign / roof air vent
- Easy-to-replace bolt on skid plate
- New product release two piece clip on roof track design to reduce downtime and replacement cost caused by forklift damage
- Corporate / company logos are easy – we will take care of it, just provide details

TWO PEICE ROOF TRACK

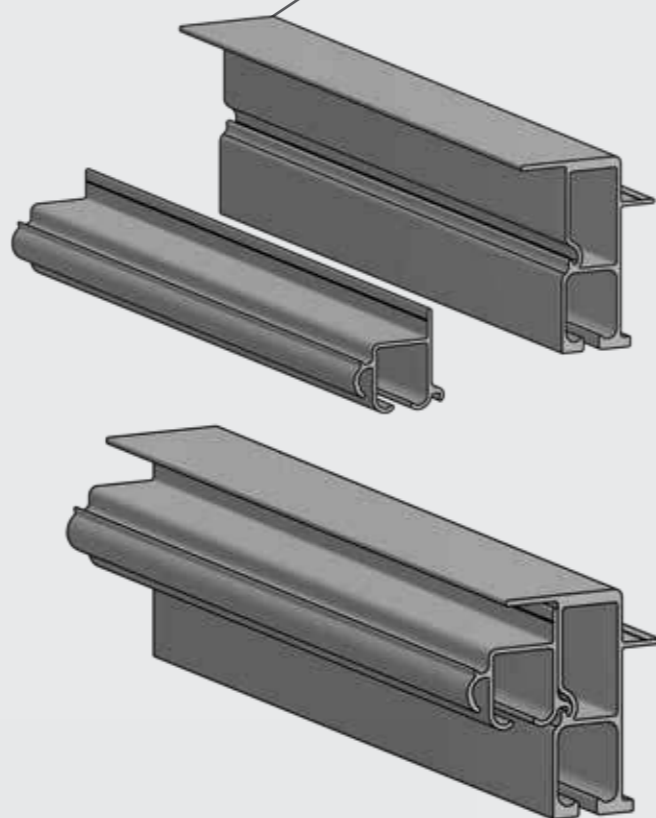

NEW DESIGN
MEZZ DECK
SLIDING POST
GREATER
FLEXIBILITY



STRAIGHT KURTAINER

LEADING EDGE

FEATURES & BENEFITS

- 45 / 48 / 53 / 34 pallet B-double / 36-pallet B-double
- Goose neck option std low profile / ultra low neck
- Food distribution full range of options for rear loading see page no
- Curtain option incl. / high productivity less buckles / buckles / insulated / load restraint rated
- Bottle and can freight available with various type of centre gate / inboard gates
- OH&S option side ladder incl. three points of contact / side gates that req. no manual lifting
- Pallet angle carrier / gate carrier under slung incl. load binder



LOAD RESTRAINT

FEATURES & BENEFITS

Krueger has spent three decades designing and testing roof track / curtain roller / curtains design incl. a range of OHS& -friendly side curtain and side gate options that are now industry std through Australia that have been responsible reducing injury / work care claim Australia wide

- Krueger roof track – fully extruded one piece alloy dual track
- Krueger designed the first sliding side post
- Curtain ratchet was designed to apply superior tensions longitudinally to curtain

- Krueger has been designing Owen curtain system for two decades
- Curtain roller dual ball bearing heavy duty essential for lasting increase of roof track life
- Award winning design Slide-A-Gate was designed 13 years ago – there are more than 10,000 currently in active service
- Self lifting gate recently designed to replace manual lifting side gate
- Two-piece roof track design now available to reduce replacement cost / downtime
- John Krueger mandates all new design tests to ensure reliability and safety prior to offering new products to customers

LOAD RESTRAINT CURTAIN



QUICK KURT



INSULATED

BUCKLE-LESS



36-PALLET DROP DECK

GENUINE LOAD RESTRAINT

FEATURES & BENEFITS

- Award-winning Slide-A-Gate
- No side gates or gate carriers required
- No load binders required for uniform pallet cargo
- Increased payload due to tare weight savings
- Quicker turnaround times – improved productivity
- Reduced OH&S issues
- Return on investment less than 12 months
- Contains and prevents load shift
- Load restraint rated one- and two-pallet high
- Compliant with NTC guidelines
- Lightweight, high strength, carbon fibre section integrated into curtain structure
- Improved freight containment



TILT BRIDGE TESTING - FULLY ENGINEERED AND APPROVED LOAD RESTRAINT



EASY TO OPERATE AND OH&S FRIENDLY



FREEZER/DRY VAN

DURABILITY

FEATURES

- Krueger and cargo bull freezer considered the best in the world
- Dry van new release now available in single and B-double models
- Food distribution rear-end loading offer a large range of options
- Rolling body chassis designed around freezer and dry van – only the best materials are used

OPTIONS

Forklift rated floor std on all models / manual and auto control rear roller door / internal load restraint / heavy duty rear end / pitt bull rear bull bar / brake interlock / dock sensing / high performance suspensions option / signage corporate logo / rear ladder with three points of contact / air lock turn table / disc brake axle plus many other options



DRY VAN



CORPORATE BRANDING SIGNAGE

Krueger has three decades of experience in working with customers to deliver their message on curtains and van walls. We work closely with our key suppliers and make the process easy – just give us the details and we will take care of it. There's no job too big or too small.



One stop shop

For quality assurance and peace of mind, all Kurtainers are supplied in excellent condition. Maintaining a solid reputation in the commercial road transport industry demands the use of the best transport equipment that Australia has to offer. Integrate Kurtainers, designed, built and finished by Krueger Transport Equipment, into your fleet with matched colours and custom signage to ensure a striking brand image.



A-DOUBLE/ROAD TRAIN DOLLY

FLEXIBILITY

FEATURES

Krueger have three decades of experience in manufacturing road dollies and A-double dollies – the latest release is a two-position draw bar length, ideal for road and A-double dual purpose dolly applications

- WA / north QLD spec available in heavy duty
- Metropolitan spec is available with two-position draw bar
- Heavy duty mud guard / plastic radius guard
- Turn range of option / draw bar leg std / spring brake release dump valve
- Bolt in towing eye / EBS full range of options

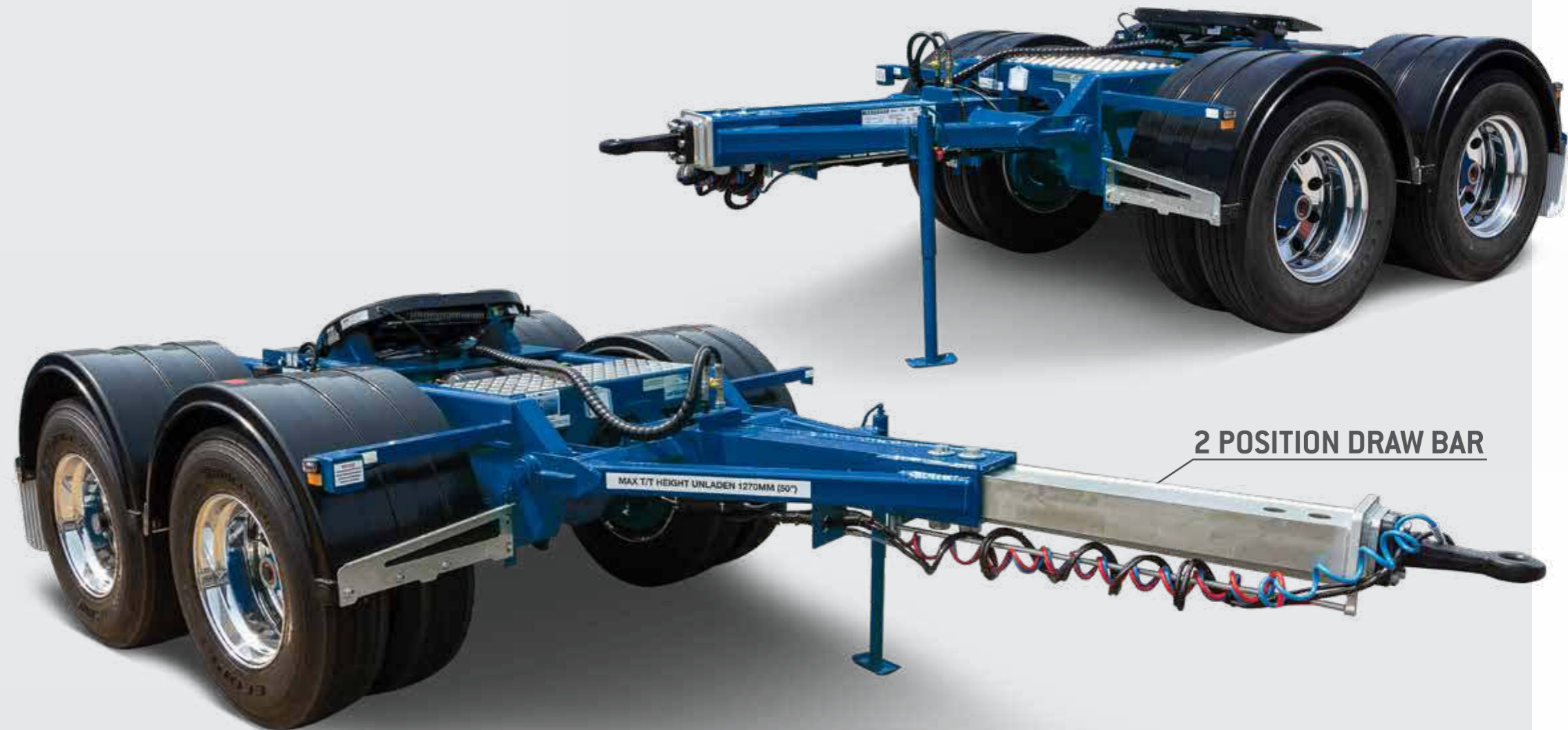

NEW PRODUCT RELEASE

Proud to announce high performance, low maintenance suspension package.

For more than two decades, Krueger Transport Equipment has continuously developed the company-owned Road Friendly Suspension to help fleets better manage Australia's harsh operating conditions with gear that allows for optimal tare weight and improved equipment longevity. This suspension is backed by a comprehensive nationwide after sales support network.

DRUM BRAKE

The drum brake Road Friendly Suspension option features a 20-inch general purpose axle in a parallel bearing combination with quick change brake shoes. The drum is enclosed in a 10-stud hub.



STEERABLE AXLE

Krueger's steerable axle configuration is optimised for vehicle manoeuvrability without compromising tare weight or equipment durability. The range includes four 20-inch self steering axles including quick change brake shoes.



Features & Benefits

- Axle now available in disc brake / drum brake incl. (million K) bearing warranty
- Bearing combination inner and outer bearing both the same large diameter
- Bearing lubricant high performance synthetic semi fluid grease
- Light weight alloy hub incl. comet plus preset bearing system incl. high torque axle nut
- Outboard brake drum / quick change brake shoes reduces maintenance time

LATEST PRODUCT RELEASE HIGH PERFORMANCE SUSPENSION/AXLE PACKAGE

ROAD FRIENDLY SUSPENSION OPTIONS



- 350 diameter air operate at lower air pressure / increase service life
- Catch strap fitted to all axle increase shocker absorbers service life
- Krueger has selected only the best in world class supplier to manufacture component parts (shocker absorbers / parabolic spring / air bag) which are European manufactured
- Krueger-owned workshop plus Brown and Hurley for product support
- Two decades of experience in air bag suspension design for Australian road conditions has lead Krueger to release this very competitive package when compared with other brands

DISC BRAKE AXLE

This disc brake axle configuration is a lighter-weight option which is specified for specific transport applications, featuring three 20-inch disc brakes and the latest Road Friendly Suspension innovations.

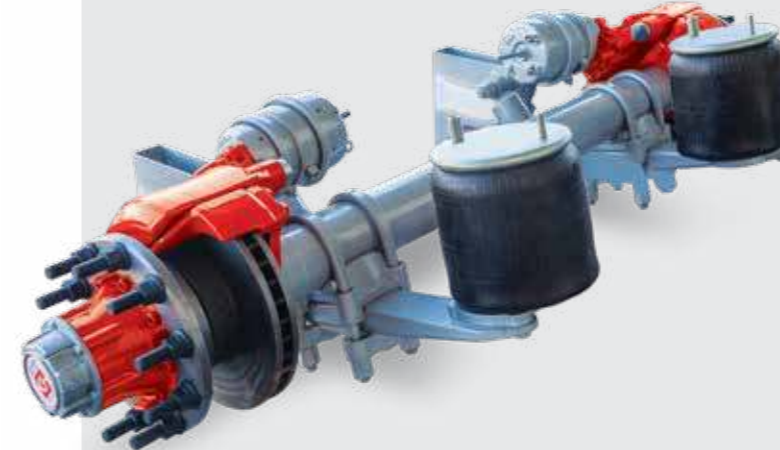

1 MILLION KM BEARING WARRANTY

Krueger designed the 1 million kilometre warranty Road Friendly Suspension model to enhance linehaul fleet requirements, emphasising reliability and long-term durability. It is available with steel or alloy hubs. The hub has preset bearings, synthetic semi-fluid lubricant requiring reduced service frequency.



OPTIONAL EXTRAS

CHASSIS OPTIONS

- 4,300 mm / 4,600mm height
- Low profile goose std on all models
- Outer perimeter / maxi internal length
- Ultra low maxi internal side opening
- Bolt on skid plate std ease of replacement

FRONT WALL OPTIONS

- Double mitred / maxi internal length
- Nose cone heavy duty std on most models
- Fridge plant provision incl. insulation

REAR WALL/DOOR OPTIONS

- Rear door hinging FRP incl. anti rank / maximum service life
- FRP fixed rear wall panel huck riveted
- Roller door whiting / manual or auto function
- Tail gate provision incl. heavy duty dock bump

ROOF OPTIONS

- Two piece clip on outer roof track riveted / ease of replacement
- 100mm styrofoam insulation
- DG air circulation roof vents

FLOOR OPTIONS

- 3mm steel check plate std inc 3/4/3 floor support
- Fork lift rated including s/s/s floor
- 3mm flat steel sheet for smooth finish to paper reels
- Alloy extruded floor / tare weight saving

FOOD DISTRIBUTION/REAR END LOADING OPTIONS

- Forklift rated floor
- Roller door manual / auto close / hinging door
- Internal load restraint cargo track to suit
- Forklift side barrier sliding for side loading
- Load restraint side-curtain range
- Sidegate range of options available
- refrigerated insulated roof / floor / curtain / other
- heavy duty dock bumper
- Bull bar heavy duty / to suit dock interlock system
- Brake interlock three-phase power connection
- Dock sensing linked to EBS braking system
- Raise lower valve / manual lower auto reset
- ILvL level manual lower / raise auto turn reset

MEZZANINE DECK/POST OPTIONS

- Mezzanine deck heavy duty 125mm incl. saddle
- Mezzanine deck 100mm incl. saddle
- New ratchet auto deck req. no saddle
- Internal load restraint net / gate
- Sliding mezz post / loading long freight

SIDE GATE OPTIONS

- Slide-A-gate load restraint rated OH&S friendly
- Self lifting gate req. no manual lifting OH&S friendly
- Kick plate / plastic lined available on all gate options
- Internal centre gate / bottle / can freight
- Gate carrier rubber mount / incl. load binder

CURTAIN RANGE OPTIONS

- Standard curtain incl. two buckles per pallet space
- Load restraint rated incl. two buckles pre-pallet space
- Quick Kurt specially designed to reduce buckles
- Buckles curtain load restraint rated OH&S friendly
- Gab handle spaced for ease of sliding curtain
- Heavy duty double bearing curtain roller
- Refrigerated insulated curtain
- Rear ratchet fast acting

LOAD BINDER OPTIONS

- Load binder std ratchet type
- Right drive load binder ratchet
- Strap and go overhead suspended load
- Handheld manual ratchet used on ultra low neck
- Pallet angle plastic type / underside pallet angle carrier

ELECTRICAL WIRING LOOM OPTIONS

- Water and dust proof wiring loom
- Anderson plug std and heavy duty
- Inline battery charging system option for
- Seven pin heavy duty plus std seven pin std plug
- Internal light incl. manual switch
- Turn table work light manual switch
- Reversing light auto / manual switch
- Reversing buzzer wired direct
- Extra LED light front wall / top rear / bottom tail light

GENERAL ACCESSORIES

- Tool box incl. chrome T latches
- 3mm heavy duty tool box
- Timber box steel sheet / wire mesh
- Stainless steel laid / stone guard
- Water tank alloy inc plastic tap
- Dock bumper steel / rubber
- Chrome hub cap / wheel nut cover
- Alloy checker plate stone guard tool box / legs / other
- Safety ladder incl. three points of contact fixed And pull out type

LANDING LEG OPTIONS

- JOST legs std on all models
- JOST module incl. compensating feet
- Razor auto raise and lower driven
- Stone guard to protect paint

SUSPENSION AXLE OPTIONS

- RFS mass management rated suspensions std Australia made
- RFS Axle inc comet plus million K bearing warranty
- RFS high performance / million K bearing warranty / catch strap / 360 air bag
- Disc brake std / million K bearing warranty
- Alloy / steel hub 10 285 PCD
- Axle lift operate manual / EBS auto raise lower
- Wheel nut indicator green and yellow type
- BPW / Hendrickson / SAF available on most models

EBS BRAKING/SUSPENSION VALVES

- EBS brand Knorr bremsse / ABC Wabco ? 12 / 24 volt
- Dock sensing auto brake control to prevent rear end damage
- Trailer information module / optilink
- ILvL auto raise lower / manual raise lower inc auto return to ride height
- Itap / tim module / other
- Dump valve to drain suspension air / spring brake release

TURN TABLE/COUPLING

- JOST 50 king pin grease type
- JOST 90 king pin grease type
- Greaseless / air locking system
- Tow coupling brands: Ringfeder, V.Orlandi or other

DG WIRING OTHER OPTION

- DG rated wiring loom / fire extinguisher
- DG sign small flip over / curtain pocket large
- Front wall vents / roof vents / rear wall vents

TYRE/RIMS/GENERAL ACCESSORIES

- Steel / alloy rims std and polished
- Tyre size range from 255R to 11R
- Brands O - green / Bridgestone / Dunlop / Goodyear

PRE DELIVERY

- Registration arrange prior to pick up
- Signage fleet number / company logo
- Curtain / body imaging company livery
- Arrange transport interstate

ATR

RENTAL OPTIONS

Advantage Trailer Rental (ATR) – a division of Krueger Transport Equipment – is a semi-trailer rental company committed to increasing the profitability and productivity of the transport industry.

As one of the largest providers of rental trailers and transport equipment in Australia, ATR has everything a modern fleet operator needs to succeed. Freight businesses across the nation can choose from a range of semi-trailers for short or long-term contracts.

Krueger Transport Equipment also complements ATR's trailer support through its national service and spare parts network. ATR has access to emergency breakdown vehicles on standby as well as a dedicated team of professionals to ensure minimal downtime and optimal value for fleet owners.



MANUFACTURING PROCESS

Krueger relies on high-tech equipment and specifies the best Australian-made high tensile steel to manufacture our trailer chassis. Our computer controlled steel cutting equipment, our auto main rail welding machine and our rotary jigs ensure we deliver perfect welds for maximum durability every time, while providing consistent quality workmanship.

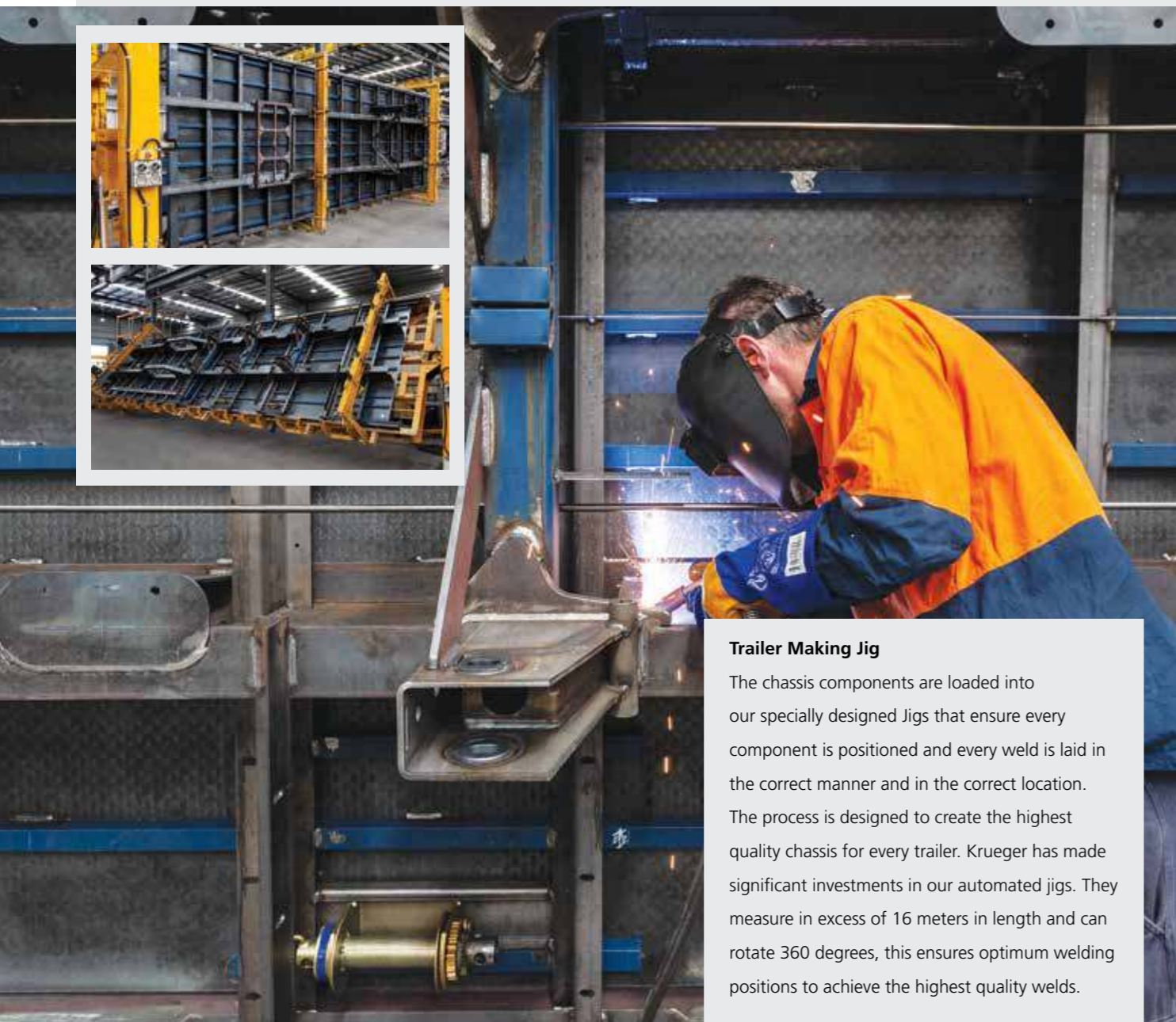

Trailer Making Jig

The chassis components are loaded into our specially designed Jigs that ensure every component is positioned and every weld is laid in the correct manner and in the correct location. The process is designed to create the highest quality chassis for every trailer. Krueger has made significant investments in our automated jigs. They measure in excess of 16 meters in length and can rotate 360 degrees, this ensures optimum welding positions to achieve the highest quality welds.

FINAL FINISH

At the final finish stage of the trailer building process, the entire steel chassis is sandblasted, undercoated and painted. Krueger goes the extra mile when it comes to achieving the best results, utilising three environmentally-friendly painting booths, which are 60' in length to ensure the biggest trailers are painted and fully sealed.

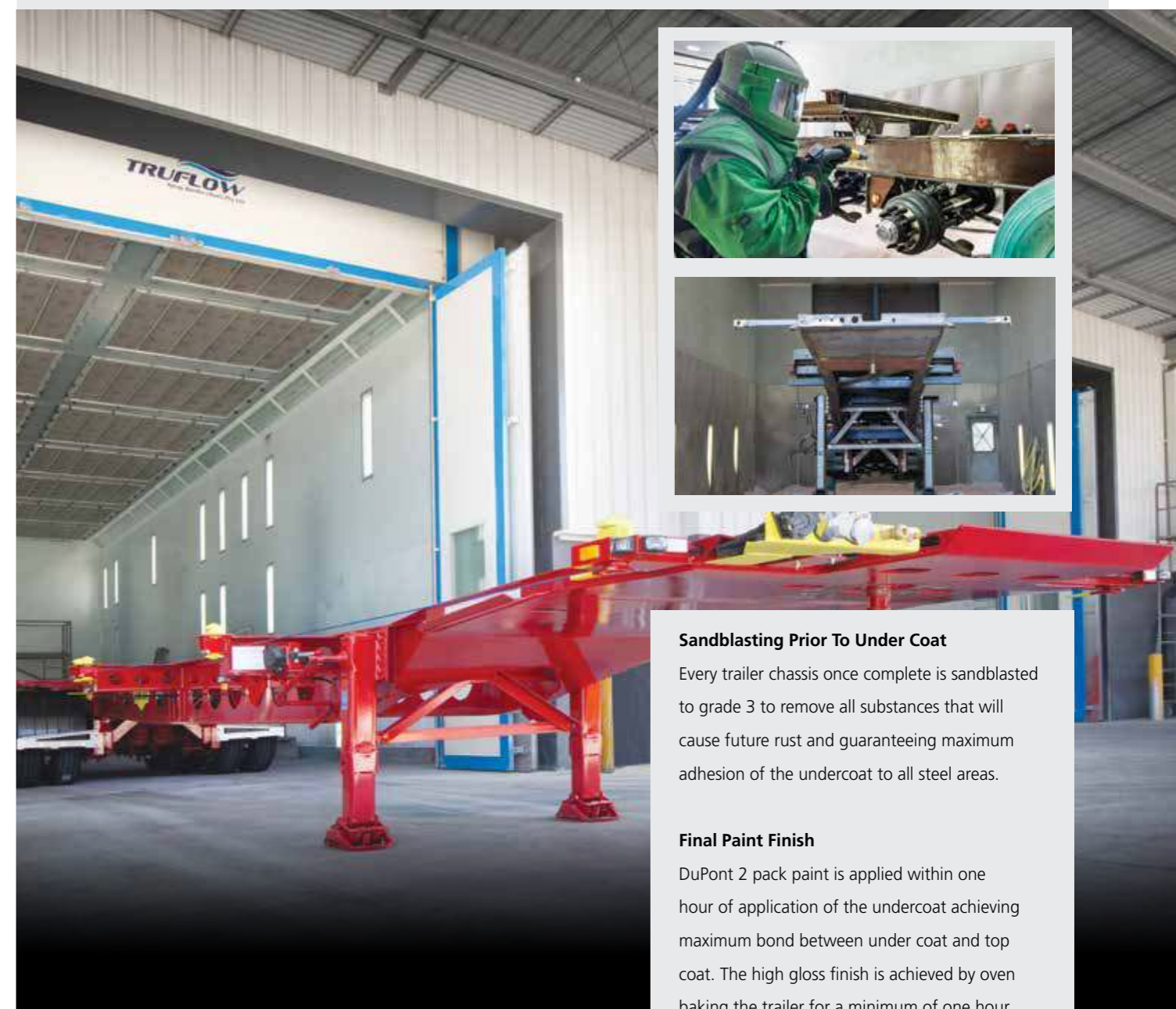

Sandblasting Prior To Under Coat

Every trailer chassis once complete is sandblasted to grade 3 to remove all substances that will cause future rust and guaranteeing maximum adhesion of the undercoat to all steel areas.

Final Paint Finish

DuPont 2 pack paint is applied within one hour of application of the undercoat achieving maximum bond between under coat and top coat. The high gloss finish is achieved by oven baking the trailer for a minimum of one hour.

SPARE PARTS

ONLINE WEBSITE
krueger.com.au/semitrailer/rfs-parts

Krueger provides full technical service and parts support via a dedicated Australia-wide network. We are now more committed than ever to strengthening customer relationships through continuous innovation and excellent customer service. For everything from axles to brake systems, Krueger has it covered.

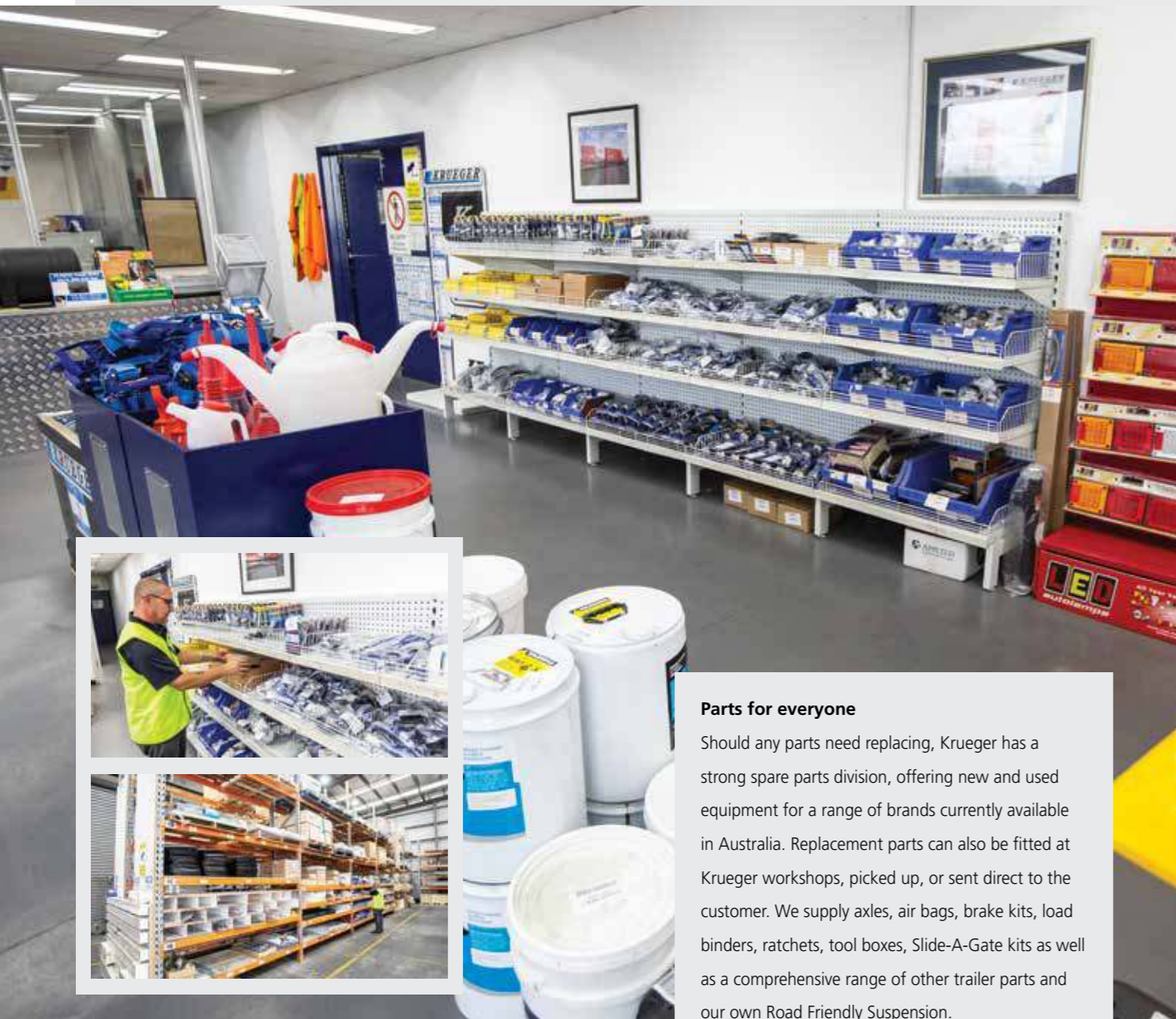

Parts for everyone

Should any parts need replacing, Krueger has a strong spare parts division, offering new and used equipment for a range of brands currently available in Australia. Replacement parts can also be fitted at Krueger workshops, picked up, or sent direct to the customer. We supply axles, air bags, brake kits, load binders, ratchets, tool boxes, Slide-A-Gate kits as well as a comprehensive range of other trailer parts and our own Road Friendly Suspension.

SERVICE AND NATIONAL SUPPORT

Krueger offers a complete national service, including fixed priced servicing, spare parts, refurbishment options, smash and damage repairs, conversions and chassis/body modifications for all brands of trailers. With workshops Australia wide, onsite and emergency vehicle support on standby. Our friendly passionate staff lead by our committed management team are here to serve our customers.

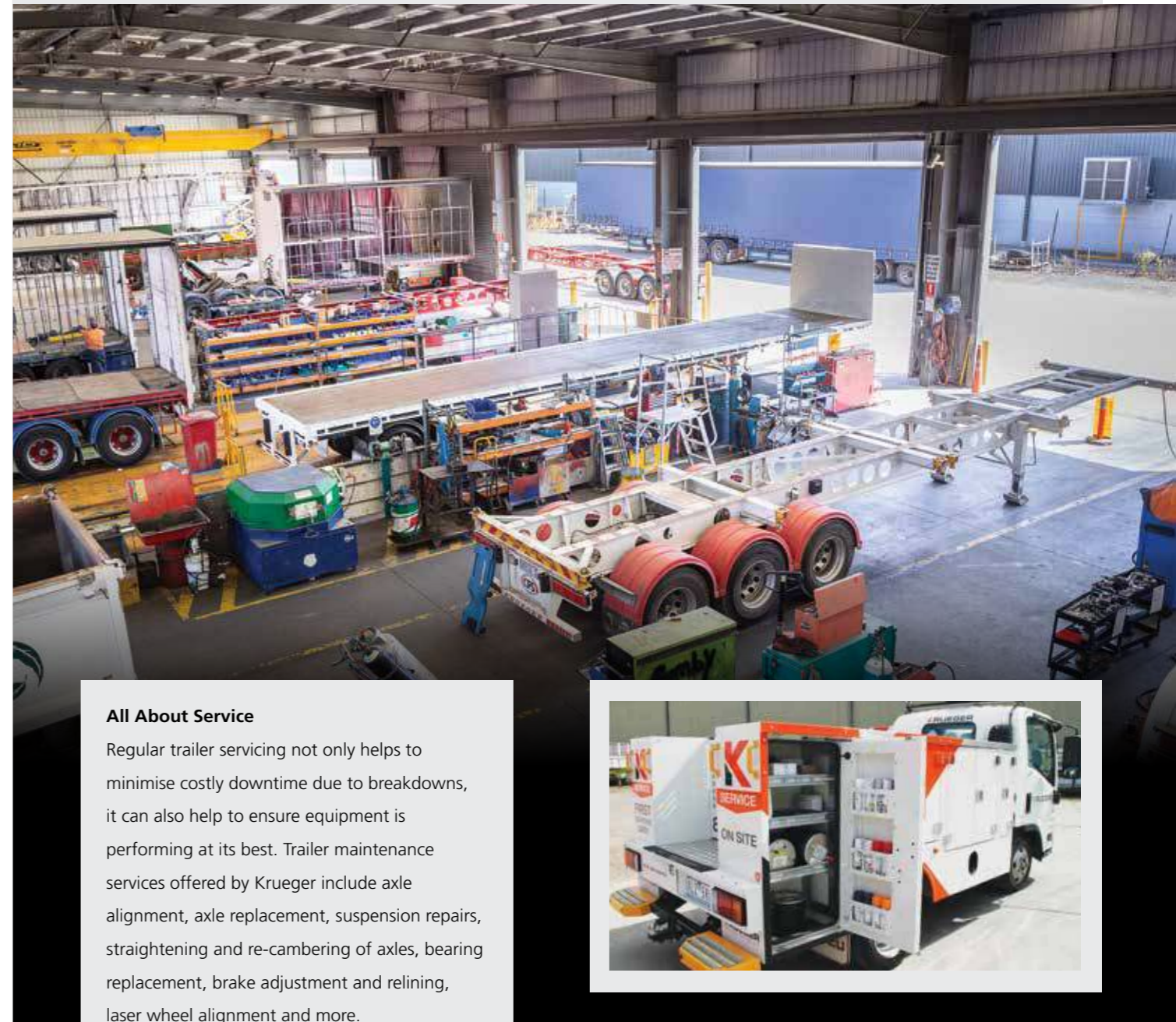

All About Service

Regular trailer servicing not only helps to minimise costly downtime due to breakdowns, it can also help to ensure equipment is performing at its best. Trailer maintenance services offered by Krueger include axle alignment, axle replacement, suspension repairs, straightening and re-cambering of axles, bearing replacement, brake adjustment and relining, laser wheel alignment and more.

NATIONAL PARTS & SERVICE SUPPORT ON YOUR DOORSTEP...

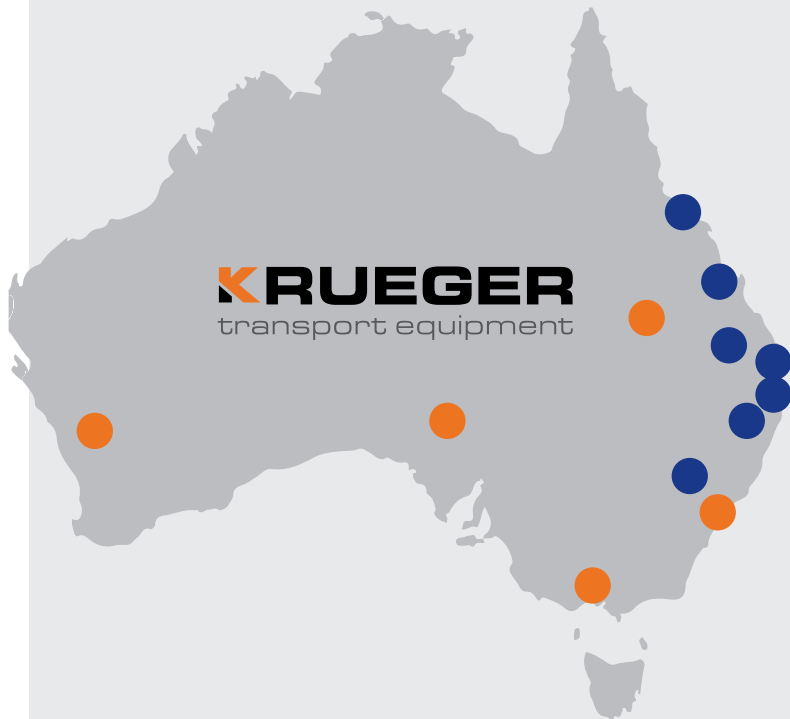

KRUEGER TRANSPORT EQUIPMENT

HEAD OFFICE

[Sales, Service
& Rentals]
Derrimut

Tel: (03) 9366 2133

NSW

[Sales, Service
& Rentals]
Wetherill Park

Tel: (02) 9757 4944

QLD

[Sales, Service
& Rentals]
Perrin Place

Tel: (07) 3275 1011

SA

[Sales, Service
& Rentals]
Wingfield

Tel: (08) 8349 4711

WA

[Sales, Service
& Rentals]
Perth

Tel: (04) 0096 2106

THE BROWN & HURLEY GROUP

Caboolture

16 Motorway Drive
Burpengary Qld 4505
07 3385 4800

Darra

2632 Ipswich Road
Darra QLD 4076
(07) 3363 8000

Rockhampton

985-1005 Yaamba Road
Parkhurst QLD 4702
(07) 4923 8000

Toowoomba

28-30 Carrington Road
Torrington QLD
(07) 4690 7300

Yatala

26 Burnside Road
Yatala QLD
(07) 3441 7000

Coffs Harbour

2-10 Hurley Drive
Coffs Harbour
NSW 2450
(02) 6648 2222

Kyogle

266 Summerland Way
Kyogle NSW 2474
(02) 6632 0333

Tamworth

81A Barnes Street
Tamworth NSW 2340
(02) 6762 2922

Townsville

662 Ingham Road
Bohle QLD
(07) 4758 4000

**THE
BROWN
AND
HURLEY
GROUP**